

Liberty Jane[®] CLOTHING

Cross Body PURSE

Intermediate Level
PDF Sewing Pattern
and Instructions

Revised &
Updated
For 2015



Learn More at
www.sewpowerful.org

CROSS BODY PURSE PATTERN

FOR GIRLS

SUPPLIES NEEDED:

- 5/8 yard of mid-weight fabric
- 1/3 yard lining
- 1/4" wide elastic (8" for cover bag, 4" option B)
- Matching thread

Additional supplies for Option B

- 1 - small decorative button
- 4" of 3/8 - 5/8" ribbon
- 1 size 4 snap

This darling cross body purse is the perfect accessory for every girl. You can achieve many different looks with the two front flap options we have included. The first option features a front pocket flap while the second option features a contrast binding and decorative ribbon. Both options give you plenty of places to add your special designer touches!

Suggested fabrics include: twill, denim, faux leather, suede, corduroy, or any other mid-weight fabric. We used a cotton for the lining. Have fun adding a little 'surprise and delight' to the inside of the bag with a printed lining or accent color. Another option for the self fabric strap is to use purchased strapping or webbing - lots of fun choices to use here too!

****NOTE:** Option A is the burgandy dot bag and Cover; Option B is the brown leather bag in the photo.



Cutting Instructions

Cut out or trace the pattern pieces provided. Identify those needed for the Option you are choosing to make - A or B. Please see below for a list of the pieces needed for each option. Please note there is not a pattern piece for the Side Panel or Purse Straps; follow the dimensions given on the pattern page. Identify those needed for the Purse fabric and those needed for lining. Fold the fabric in half along lengthwise grain for double thickness for Purse Front and Back, Purse Top Front and Back, Purse Lining, Lining Top, Front Pocket Flap (A) and Front Pocket Sides (B). All other pieces are Cut 1 and only require a single layer. Place pieces on fabric and pin, following grainlines indicated on pattern. Cut out all of the pieces. A suggested cutting layout is offered below.

Pieces needed: **Both Options:** 6, 7, 8, 9, 10, 11

Option A: 1, 2, 3, 4, 5

Option B: 12, 13, 14, 15, 16, 17

Layout for Option A - (cover photo)

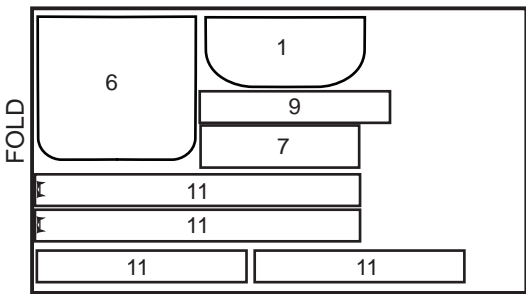

*Single layer

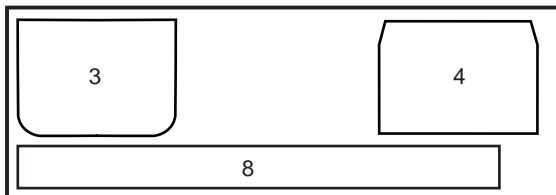

Layout for Option B

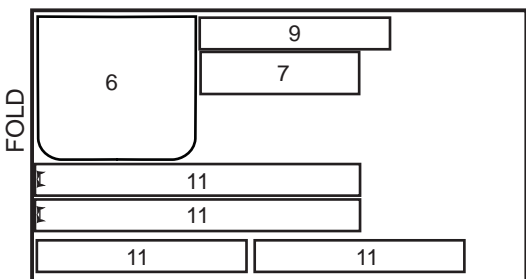

*Single layer

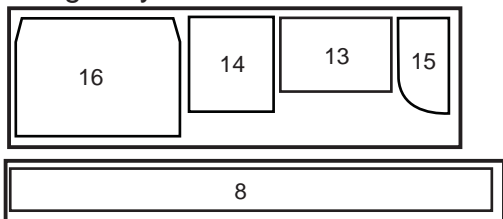

Cut Pieces for Cross Body Purse



Cut Pieces for Option A - Pocket w/ flap



Cut Pieces for Option B



Layout for Lining - Options A & B

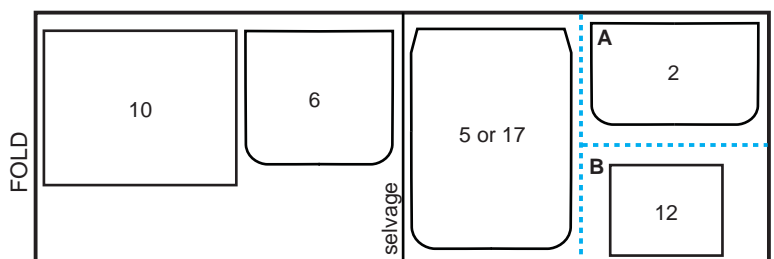

Sewing Instructions

This Cross Body Purse pattern comes with two different front flap/pocket options. This first option has a pocket flap over the pocket. The second option features the same pocket technique using an inverted pleat and elastic casing but does not include a pocket flap. The actual bag construction is the same for both bags, with instructions starting on page 13. To begin Option B, start on page 8.



Option A - as seen on the cover **Front Pocket with pocket flap**

1. Interface **WRONG** side of one Front Pocket Flap (1) if needed.

With **RIGHT** sides together, pin Front Pocket Flaps together along sides and curved edge. Stitch.

2. Clip corners as needed. Turn right side out. Press flat.

3. Edgestitch to finish.

Sew on trim along curved edge if desired. Set Aside.

4. With **RIGHT** sides together, pin Front Flap Pocket (2) to Front Flap Pocket Lining (2) along top edge. Stitch.

5.



5. With WRONG sides together, fold Front Flap Pocket and Lining along seam. Press flat.

6.



6. TOPSTITCH 3/8" away from fold to create a casing.

7.



7. Baste raw edges together along curve.

8.



8. To make inverted pleat at bottom of pocket, bring solid lines to center marking. Press flat and pin. Baste in pleat.

9.



9. Thread a 7 3/4" length of 1/4" wide elastic through casing. Secure at both ends.

10.



10. With RIGHT sides facing UP, place Front Flap Pocket on top of Purse Flap A (3), matching raw edges along bottom and sides (top edge of Front Flap Pocket should be 5/8" lower than top raw edge of Purse Flap).

11.



11. With RIGHT sides facing UP, place Front Pocket Flap onto Purse Flap A, matching top raw edges. Pin and baste.

****NOTE:** Flap should end 1/4" shy of each side to allow for seam allowance.

12.



12. With RIGHT sides together, pin Purse Flap B (4) to Purse Flap A along straight edge. Stitch through all layers.

13.



13. Press seam toward Purse Flap B. Edge-stitch if desired.

****OPTIONAL:** Sew on trim along trim line as indicated on Purse Flap B.

14.



14. With RIGHT sides together, pin Purse Flap Lining (5) to Purse Flap along sides and lower edge. Stitch.

15.



15. Clip corners as necessary. Turn right side out and gently press seam flat.

16.



16. Edgestitch around seam, breaking stitching at Pocket Flap.



**Finished Purse Flap is shown left.

Proceed to Step 17 on page 13 for Bag Construction.

Option B Directions

Front Flap Pocket with decorative button and ribbon loop

1.



1. With RIGHT sides together, pin Front Pocket (13) to Front Pocket Lining (12) at top edge. Stitch.

2.



2. Press seam open.

3.



3. Match up raw edges along bottom edge and press in fold.

4.



4. Stitch-in-the-ditch, 3/8" away from fold to form casing.

5.



5. Baste raw edges together from seam down around 3 sides (leave casing open).

6.



6. To make inverted pleat along bottom edge, bring solid lines to center notch. Baste.

7.



7. Thread a 3 3/4" piece of 1/4" wide elastic through top casing. Stitch ends to secure.

8.



8. Place Front Pocket onto Front Center Under Pocket (14), matching top edge of casing to notches. Baste.

9.



9. With RIGHT sides together, pin Front Pocket Sides (15) onto Front Pocket. Stitch. Press seam toward Front Pocket Side.

10.



10. Edgestitch close to seam on Side piece. Topstitch again 3/16" away from seam to create a double needle topstitch.

11.



11. Fold 4" piece of ribbon in half. Baste raw edges of ribbon tab to top of Under Pocket.

12.



12. With RIGHT sides together, pin Front Flap (16) to Front Pocket. Stitch.

13.



13. Press seam toward Front Flap. Edgestitch along seam. Topstitch again 3/16" away from seam to create a double needle topstitch.

14.



14. With RIGHT sides together, pin Front Flap to Flap Lining (17) around all sides except top edge. Stitch.

15.



15. Clip corners and turn right side out. Gently press edges flat.

Edgestitch along outer edge.

16.



16. Sew on a decorative button to ribbon tab. Sew on a snap under ribbon tab to secure to pocket.



**Finished Flap is shown left.

Bag Construction (both options)

17.



17. With RIGHT sides together, center Pocket Flap (lining side up) on top of Purse Back (6), with raw edges lined up.

18.



18. With the WRONG side facing up, place Purse Top Back (7) on top of the Purse Flap. Pin. Stitch through all layers.

19.



19. Press seam toward Purse Back. Edge-stitch along seam on Purse Back side. Set aside.

20.



**Purse Front has two layers to create a pocket; this is the outside layer.

20. With RIGHT sides together, pin Purse Front (6) to Purse Front Lining (6) along top edge. Stitch.

21.

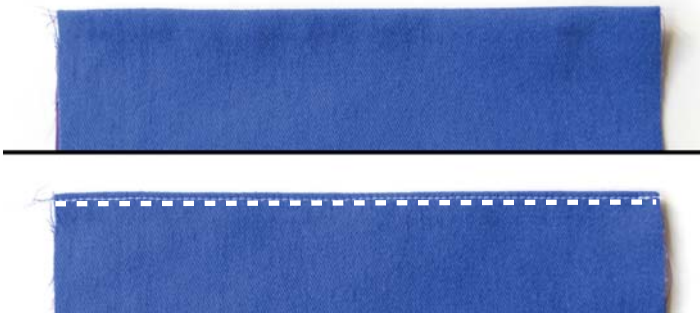

21. With WRONG sides together, fold Purse Front and Purse Front lining along seam. Press flat.

Edgestitch along seam.

22.



**Inside layer of Purse Front

22. With RIGHT sides together, pin Purse Top Front (7) to Purse Front Lining (6) along top edge. Stitch.

23.



23. Press seam toward lining. Edgestitch along lining side.

24.



24. With RIGHT sides facing up, place Purse Front on top of Purse Top Front/Lining piece, just covering seam. **Top layer may be a little shorter than under layer at bottom edges.

Pin layers together and baste around side and bottom edges to form pocket.

25.



25. Make a mark in the center of Purse Front along bottom edge (as indicated on pattern).

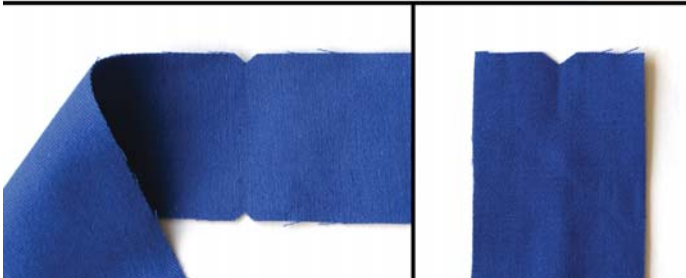

Fold Side Panel (8) in half. Mark notches at the center of Side Panel, top and bottom.



26. With RIGHT sides together, pin Side Panel around Purse Front, lining up the center markings. Cut small slits into the seam allowance of Side Panel at corners to turn smoothly. **Raw edges should line up at top.

Stitch around the outside edge using 1/4" seam allowance.



27. With RIGHT sides together, match the center of Side Panel with the center marking on Purse Back piece.



28. Pin around outside edge as done in Step 26. Stitch.

29.



29. Turn bag right side out and set aside.

30.



Lining

30. With RIGHT sides together, pin Lining Top (9) to Lining (10) along top edge. Stitch. Press seam toward lining.



Topstitch if desired. REPEAT for other piece.

31.



31. With RIGHT sides together, pin sides and bottom edge. Sew along the left and right sides, turning corner, and stopping at circles (as marked on pattern). Leave center bottom open to turn purse right side out. **Do not sew along top edge.

32.



32. Slide Purse into Lining, with RIGHT sides together. **Be sure to match up the lining side seam with the center of the purse side piece. Pin around entire top edge. Stitch.

33.



33. Turn Purse RIGHT side out by pulling through bottom opening in lining.

34.



34. Fold raw edges of lining to the inside and topstitch closed.



35.



35. Stuff lining back inside of the purse. Press top edge of purse. Topstitch if desired.

36.



Purse Strap (11)

36. With RIGHT sides together, pin the end of one short piece to the end of long piece. Stitch. With RIGHT sides together, pin second short piece to the other end of the long piece. Stitch. **Long piece will now be in the center of the strap.

Press seam toward long piece. Topstitch along seam. REPEAT for remaining strap pieces.

37.



37. With RIGHT sides together, sew the two straps together along one long edge, being sure to match pieced seams.

38.



38. Press seam open. Press each long, raw edge under 1/4". With RIGHT sides together, fold strap in half lengthwise and pin, matching pieced seams. Stitch along pinned edge.

39.



39. Topstitch along other side to complete strap.

40.



40. With RIGHT sides together, place the raw end of strap on the side of purse, 1/2" away from the top edge of purse. Stitch along the end to secure.

41.



41. Fold Strap up and pin in place.

42.



42. Sew a square shape around the strap end.

Sew an 'X' shape for durability.



Finished Bag!



Summary of Instructions

1. Interface WRONG side of one Front Pocket Flap (1) if needed.
With RIGHT sides together, pin Front Pocket Flaps together along sides and curved edge. Stitch.
2. Clip corners as needed. Turn right side out. Press flat.
3. Edgestitch to finish. Sew on trim along curved edge if desired. Set Aside.
4. With RIGHT sides together, pin Front Flap Pocket (2) to Front Flap Pocket Lining (2) along top edge. Stitch.
5. With WRONG sides together, fold Front Flap Pocket and Lining along seam. Press flat.
6. TOPSTITCH 3/8" away from fold to create a casing.
7. Baste raw edges together along curve.
8. To make inverted pleat at bottom of pocket, bring solid lines to center marking. Press flat and pin. Baste in pleat.
9. Thread a 7 3/4" length of 1/4" wide elastic through casing. Secure at both ends.
10. With RIGHT sides facing UP, place Front Flap Pocket on top of Purse Flap A (3), matching raw edges along bottom and sides (top edge of Front Flap Pocket should be 5/8" lower than top raw edge of Purse Flap).
11. With RIGHT sides facing UP, place Front Pocket Flap onto Purse Flap A, matching top raw edges. Pin and baste. **NOTE: Flap should end 1/4" shy of each side to allow for seam allowance.
12. With RIGHT sides together, pin Purse Flap B (4) to Purse Flap A along straight edge. Stitch through all layers.
13. Press seam toward Purse Flap B. Edgestitch if desired.
**OPTIONAL: Sew on trim along trim line as indicated on Purse Flap B.
14. With RIGHT sides together, pin Purse Flap Lining (5) to Purse Flap along sides and lower edge. Stitch.
15. Clip corners as necessary. Turn right side out and gently press seam flat.
16. Edgestitch around seam, breaking stitching at Pocket Flap.
**Proceed to Step 17 on page 23 for Bag Construction.

Option B Pocket Directions

Front Flap Pocket

1. With RIGHT sides together, pin Front Pocket (13) to Front Pocket Lining (12) at top edge. Stitch.
2. Press seam open.
3. Match up raw edges along bottom edge and press in fold.
4. Stitch-in-the-ditch, 3/8" away from fold to form casing.
5. Baste raw edges together from seam down around 3 sides (leave casing open).
6. To make inverted pleat along bottom edge, bring solid lines to center notch. Baste.

7. Thread a 3 3/4" piece of 1/4" wide elastic through top casing. Stitch ends to secure.
8. Place Front Pocket onto Front Under Pocket (14), matching top edge of casing to notches. Baste.
9. With RIGHT sides together, pin Front Pocket Sides (15) onto Front Pocket. Stitch. Press seam toward Front Pocket Side.
10. Edgestitch close to seam on Side piece. Topstitch again 3/16" away from seam to create a double needle topstitch.
11. Fold 4" piece of ribbon in half. Baste raw edges of ribbon tab to top of Under Pocket.
12. With RIGHT sides together, pin Front Flap (16) to Front Pocket. Stitch.
13. Press seam toward Front Flap. Edgestitch along seam. Topstitch again 3/16" away from seam to create a double needle topstitch.
14. With RIGHT sides together, pin Front Flap to Flap Lining (17) around all sides except top edge. Stitch.
15. Clip corners and turn right side out. Gently press edges flat. Edgestitch along outer edge.
16. Sew on a decorative button to ribbon tab. Sew on a snap under ribbon tab to secure to pocket.

Bag Construction

17. With RIGHT sides together, center Pocket Flap (lining side up) on top of Purse Back (6), with raw edges lined up.
 18. With the WRONG side facing up, place Purse Top Back (7) on top of the Purse Flap. Pin. Stitch through all layers.
 19. Press seam toward Purse Back. Edgestitch along seam on Purse Back side. Set aside.
- **Purse Front has two layers to create a pocket; this is the outside layer.
20. With RIGHT sides together, pin Purse Front (6) to Purse Front Lining (6) along top edge. Stitch.
 21. With WRONG sides together, fold Purse Front and Purse Front lining along seam. Press flat. Edgestitch along seam.
- **Inside layer of Purse Front
22. With RIGHT sides together, pin Purse Top Front (7) to Purse Front Lining (6) along top edge. Stitch.
 23. Press seam toward lining. Edgestitch along lining side.
 24. With RIGHT sides facing up, place Purse Front on top of Purse Top Front/Lining piece, just covering seam. **Top layer may be a little shorter than under layer at bottom edges. Pin layers together and baste around side and bottom edges to form pocket.
 25. Make a mark in the center of Purse Front along bottom edge (as indicated on pattern). Fold Side Panel (8) in half. Mark notches at the center of Side Panel, top and bottom.
 26. With RIGHT sides together, pin Side Panel around Purse Front, lining up the center markings. Cut small slits into the seam allowance of Side Panel at corners to turn smoothly. **Raw edges should line up at top. Stitch around the outside edge using 1/4" seam allowance.
 27. With RIGHT sides together, match the center of Side Panel with the center marking on Purse Back piece.

28. Pin around outside edge as done in Step 26. Stitch.
29. Turn bag right side out and set aside.
30. With RIGHT sides together, pin Lining Top (9) to Lining (10) along top edge. Stitch. Press seam toward lining. Topstitch if desired. REPEAT for other piece.
31. With RIGHT sides together, pin sides and bottom edge. Sew along the left and right sides, turning corner, and stopping at circles (as marked on pattern). Leave center bottom open to turn purse right side out. **Do not sew along top edge.
32. Slide Purse into Lining, with RIGHT sides together. **Be sure to match up the lining side seam with the center of the purse side piece. Pin around entire top edge. Stitch.
33. Turn Purse RIGHT side out by pulling through bottom opening in lining.
34. Fold raw edges of lining to the inside and topstitch closed.
35. Stuff lining back inside of the purse. Press top edge of purse. Topstitch if desired.

Purse Strap

36. With RIGHT sides together, pin the end of one short piece to the end of long piece. Stitch. With RIGHT sides together, pin second short piece to the other end of the long piece. Stitch. **Long piece will now be in the center of the strap. Press seam toward long piece. Topstitch along seam. REPEAT for remaining strap pieces.
37. With RIGHT sides together, sew the two straps together along one long edge, being sure to match pieced seams.
38. Press seam open. Press each long, raw edge under 1/4". With RIGHT sides together, fold strap in half lengthwise and pin, matching pieced seams. Stitch along pinned edge.
39. Topstitch along other side to complete strap.
40. With RIGHT sides together, place the raw end of strap on the side of purse, 1/2" away from the top edge of purse. Stitch along the end to secure.
41. Fold Strap up and pin in place.
42. Sew a square shape around the strap end. Sew an 'X' shape for durability.



Cross Body **PURSE**

Intermediate Level
PDF Sewing Pattern
and Instructions





Cross Body **PURSE**

Intermediate Level
PDF Sewing Pattern
and Instructions

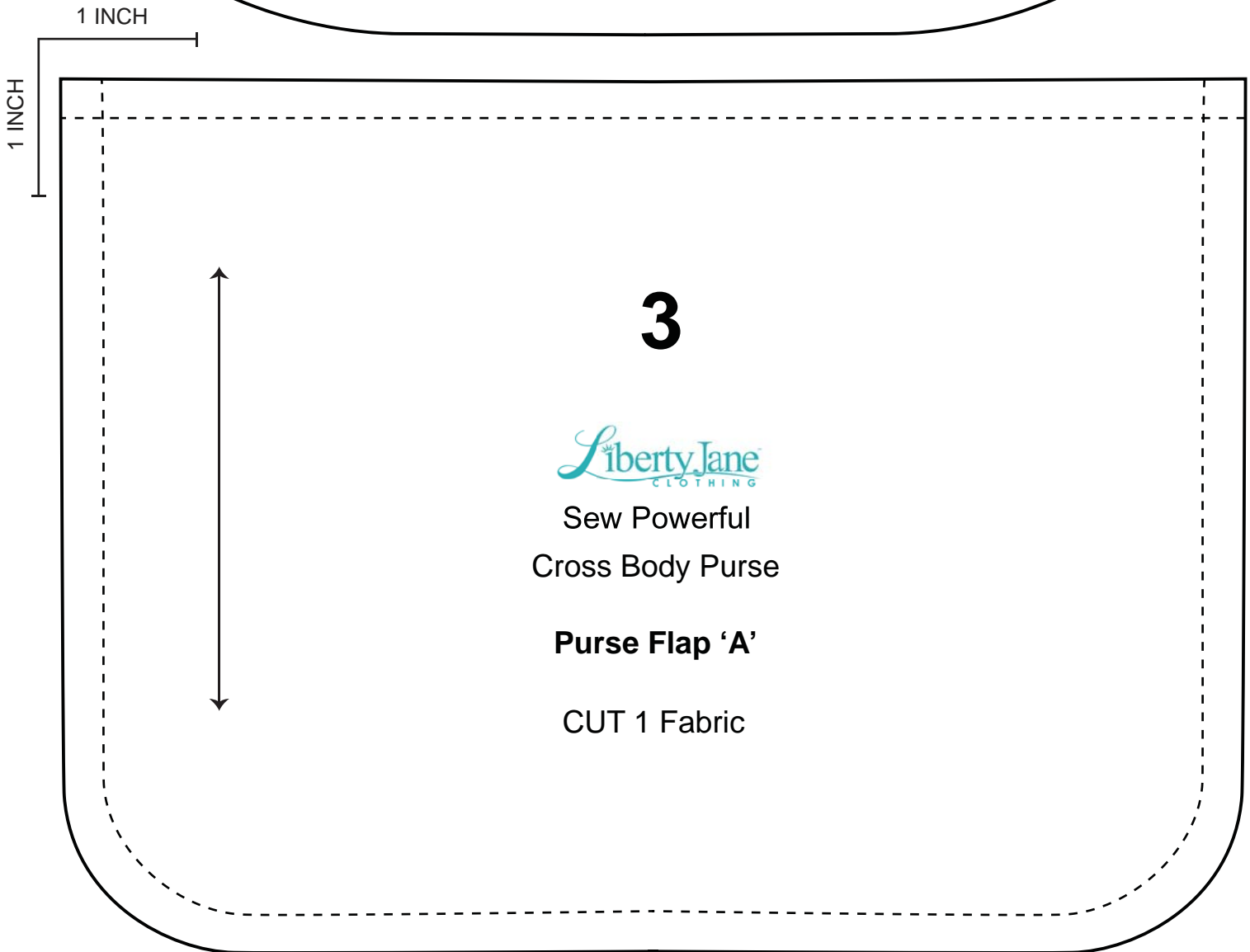

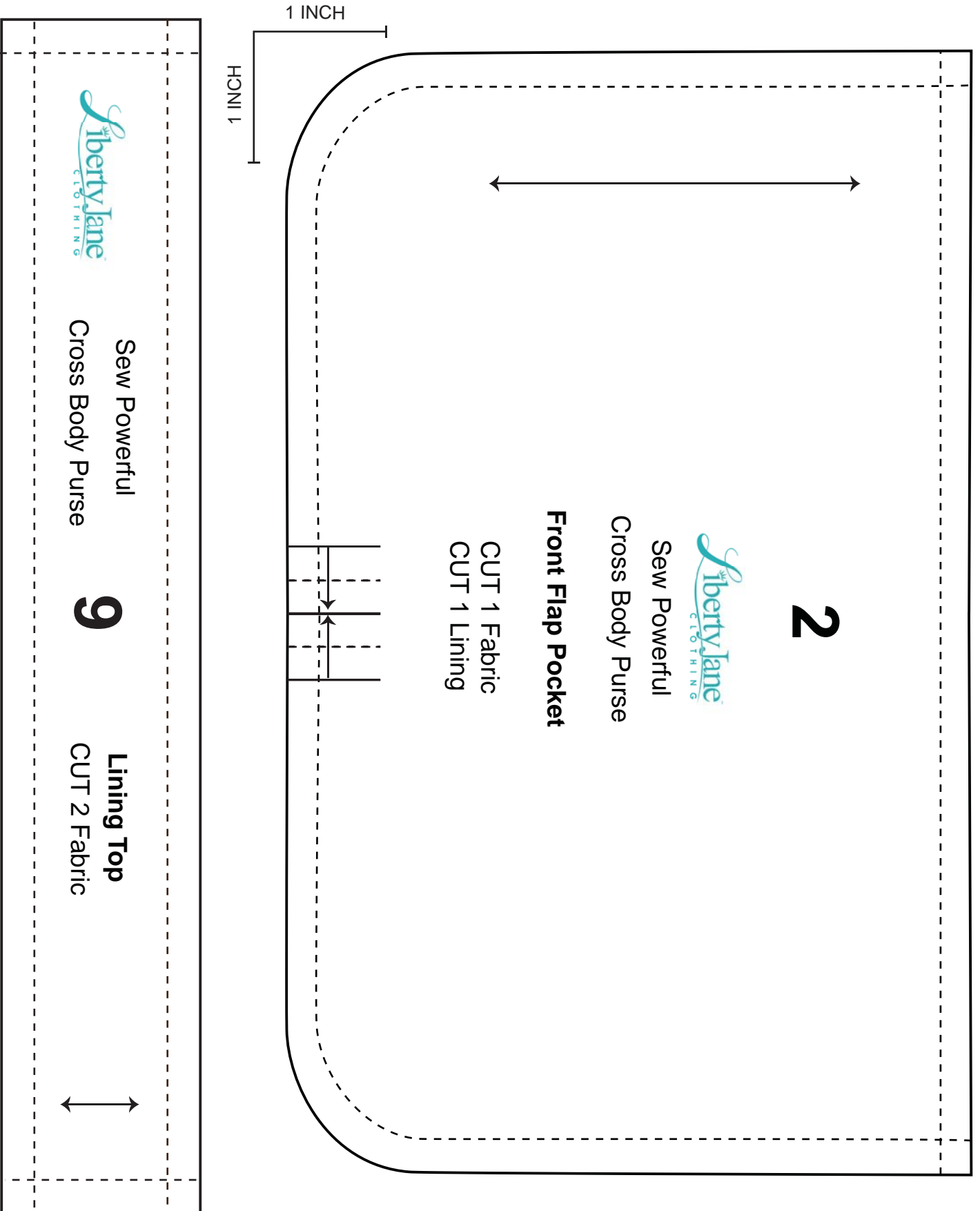

These patterns are intended for personal use, not for large scale commercial purposes or manufacturing. To inquire about using them for work from home selling, please email support@pixiefaire.com and request the Partnership Terms and Agreement document. Copyright © 2015 Liberty Jane Clothing All rights reserved.

8
Side Panel
CUT 1 of Fabric
2" x 22"

11
Purse Strap
CUT 2 - 30 1/2" x 1 1/2"
CUT 4 - 10 1/2" x 1 1/2"

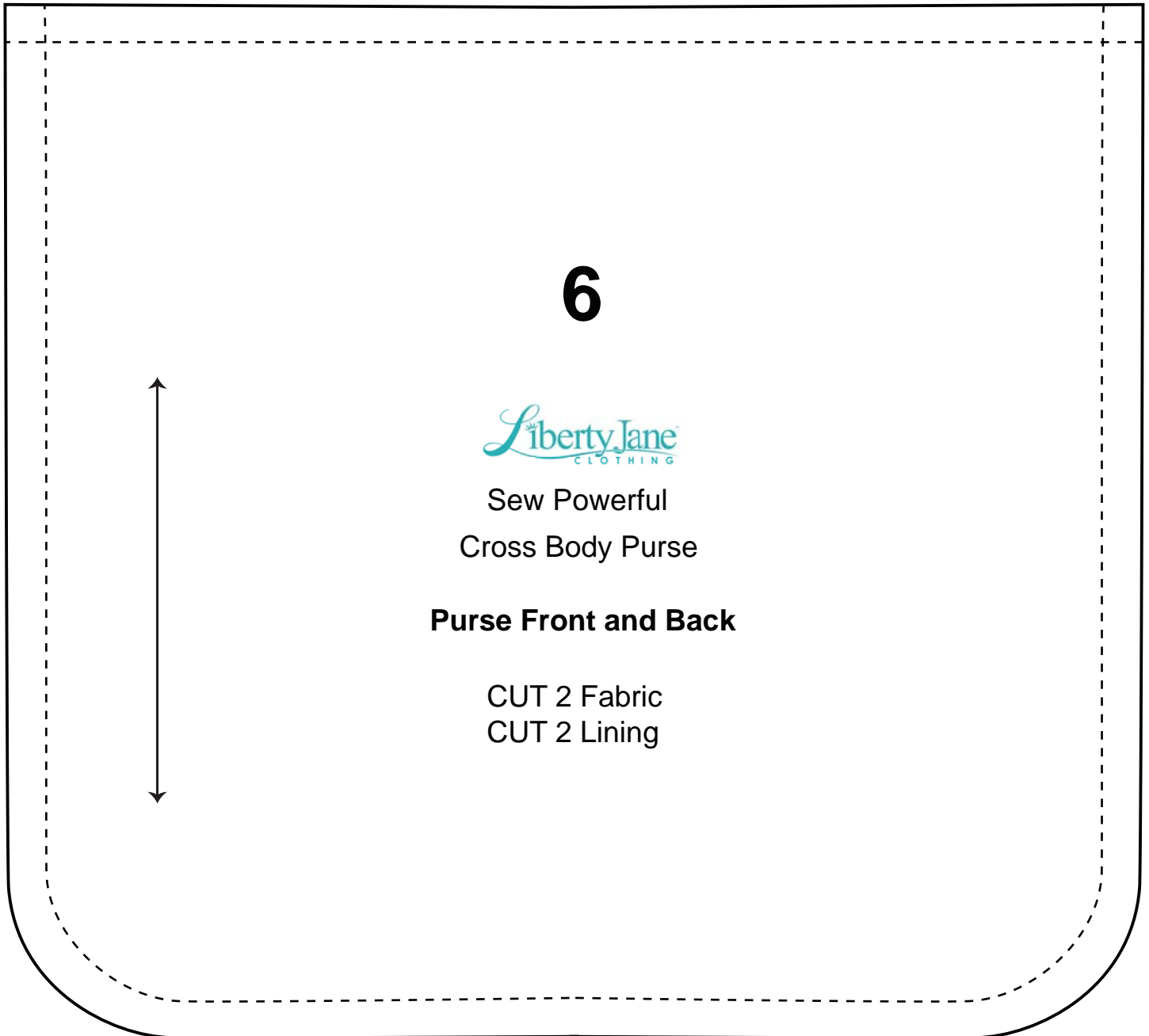
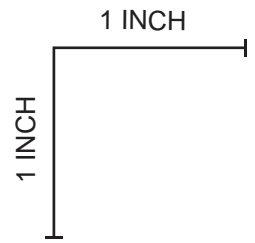

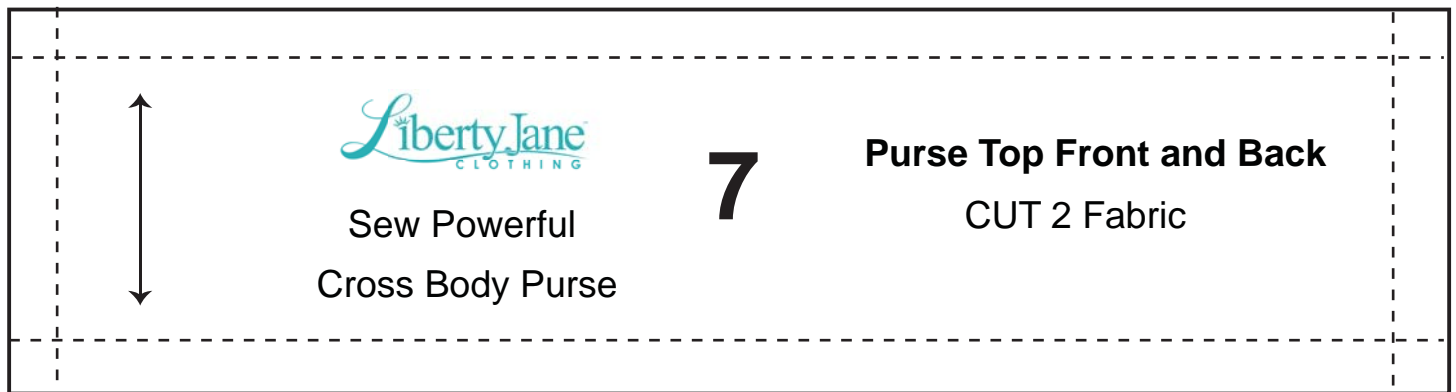
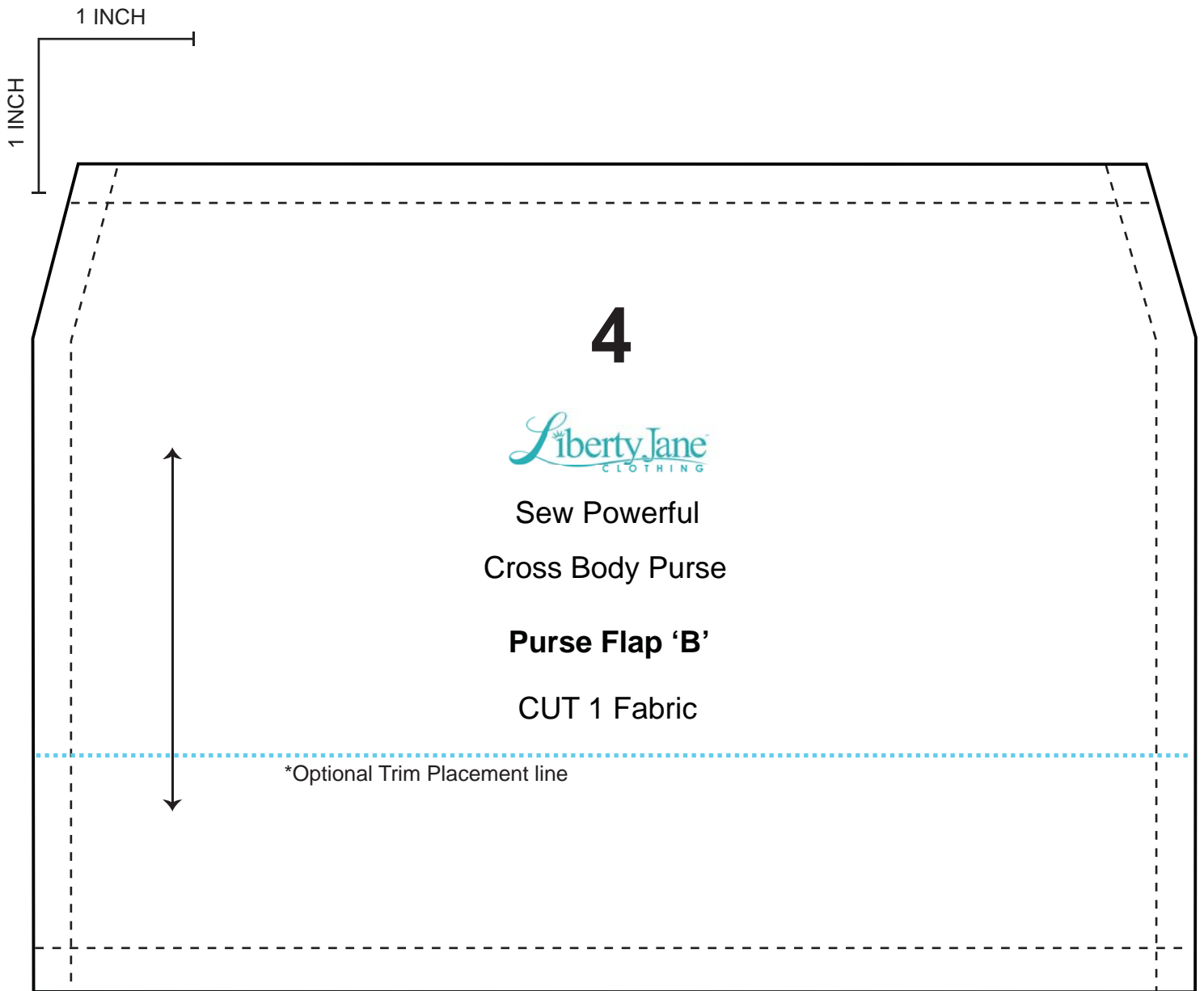

These patterns are intended for personal use, not for large scale commercial purposes or manufacturing. To inquire about using them for work from home selling, please email support@pixiefaire.com and request the Partnership Terms and Agreement document.
Copyright © 2015 Liberty Jane Clothing All rights reserved.



5

Liberty Jane
CLOTHING

Sew Powerful
Cross Body Purse

Flap Lining

CUT 1 Lining

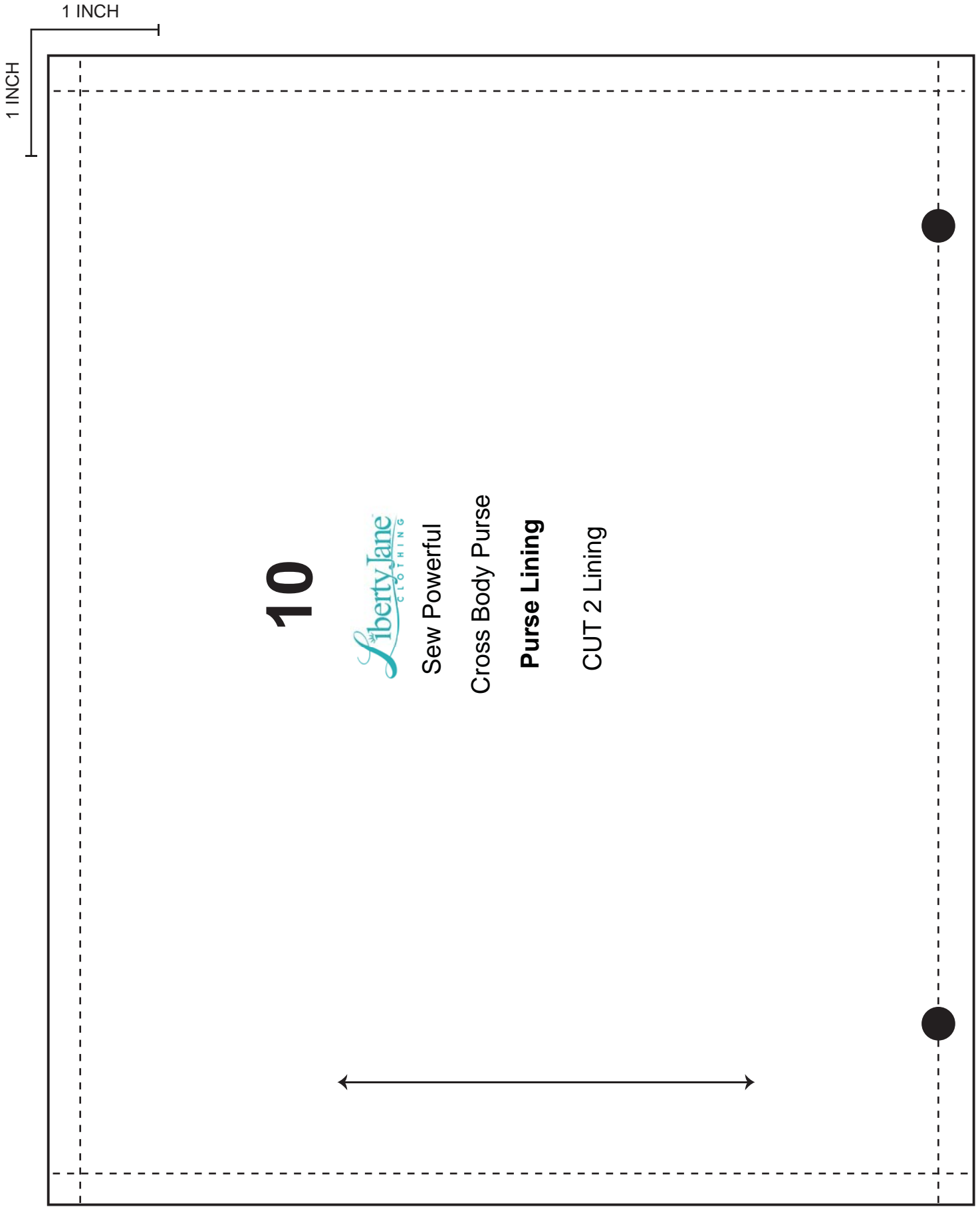

10



Sew Powerful
Cross Body Purse
Purse Lining
CUT 2 Lining

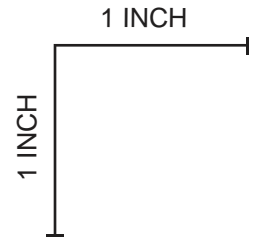
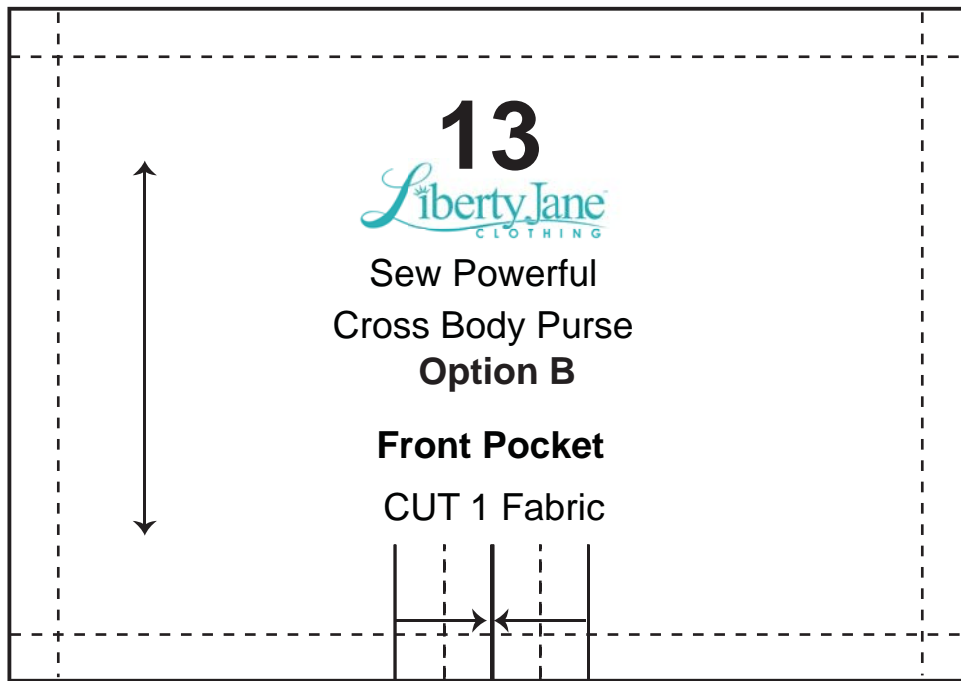

Option B Pattern

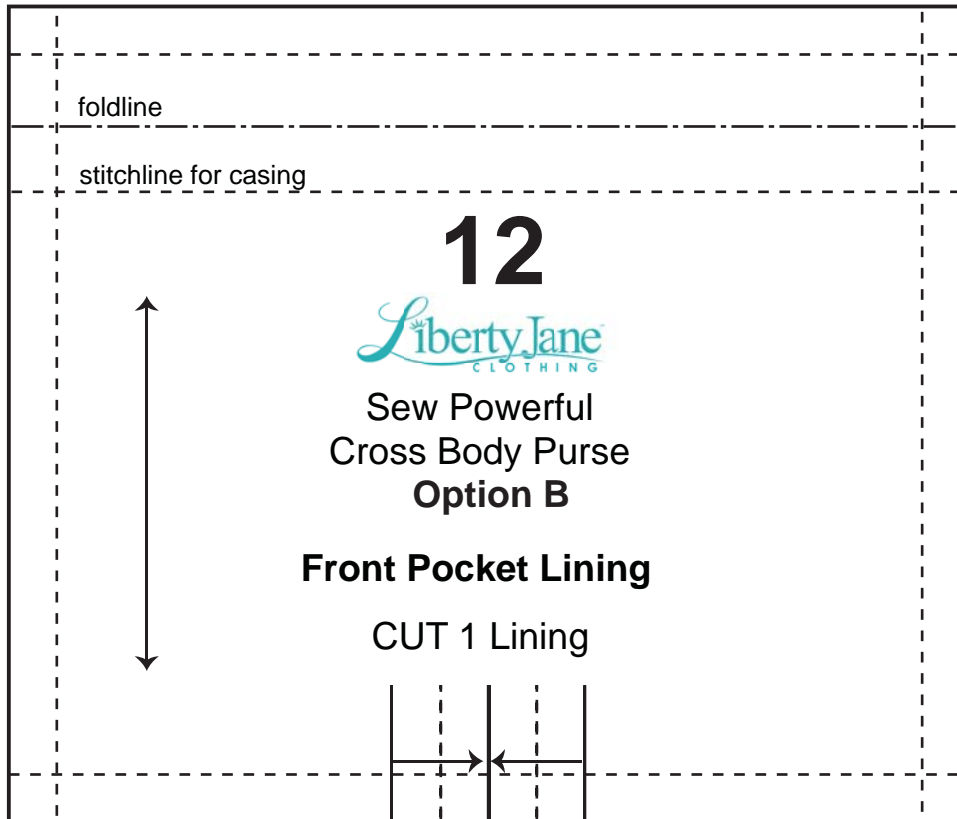
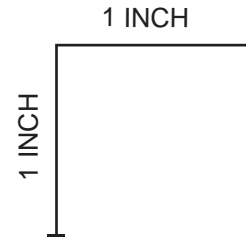
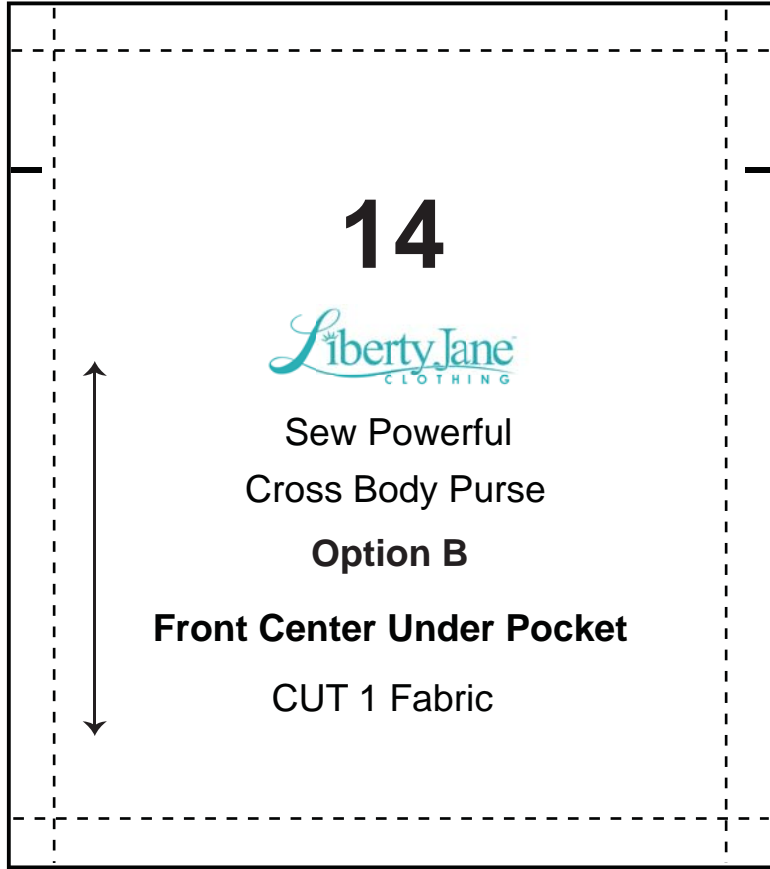

These patterns are intended for personal use, not for large scale commercial purposes or manufacturing. To inquire about using them for work from home selling, please email support@pixiefaire.com and request the Partnership Terms and Agreement document.
Copyright © 2015 Liberty Jane Clothing All rights reserved.

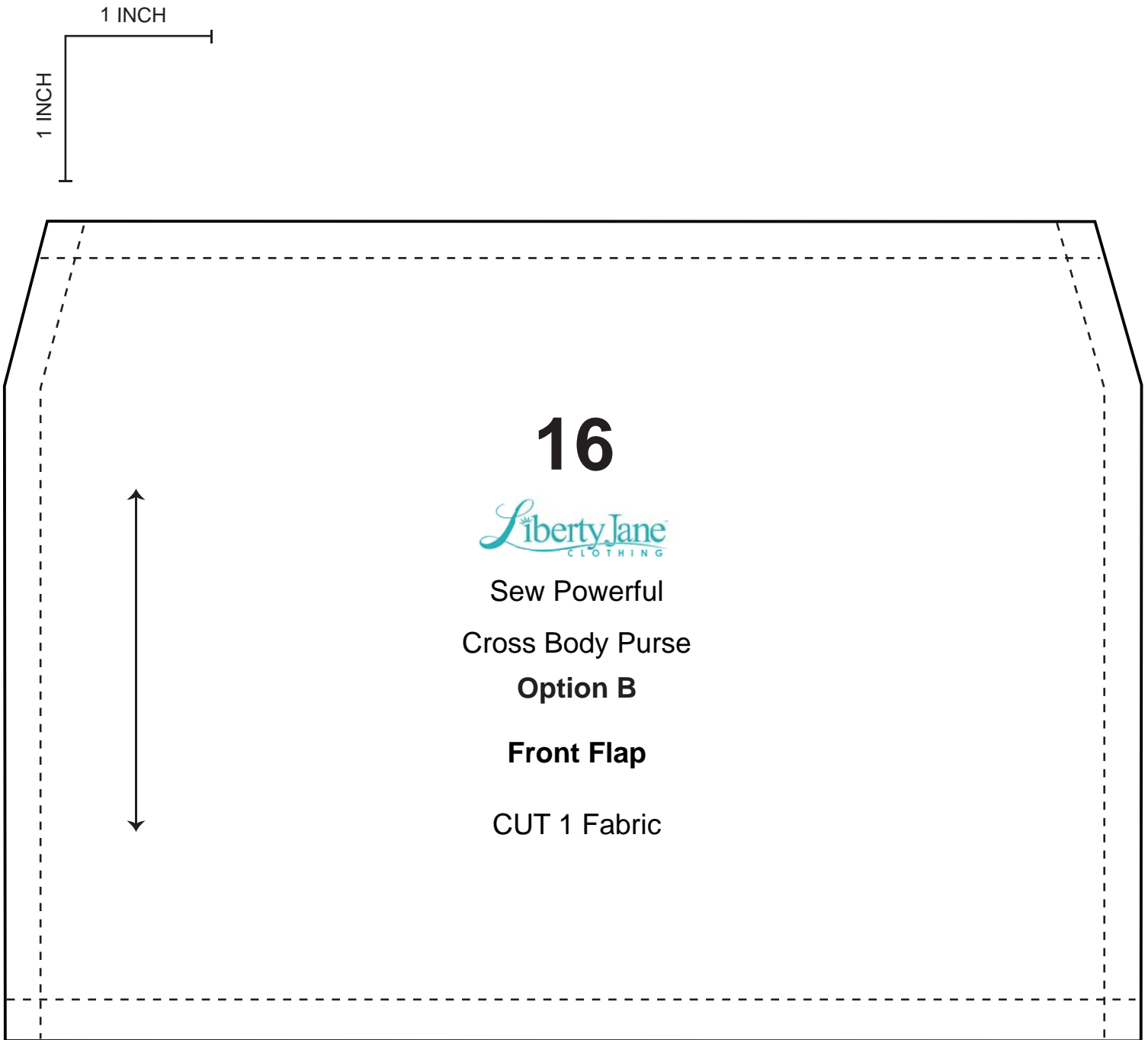

17



Sew Powerful

Cross Body Purse

Option B

Flap Lining

CUT 1 Lining

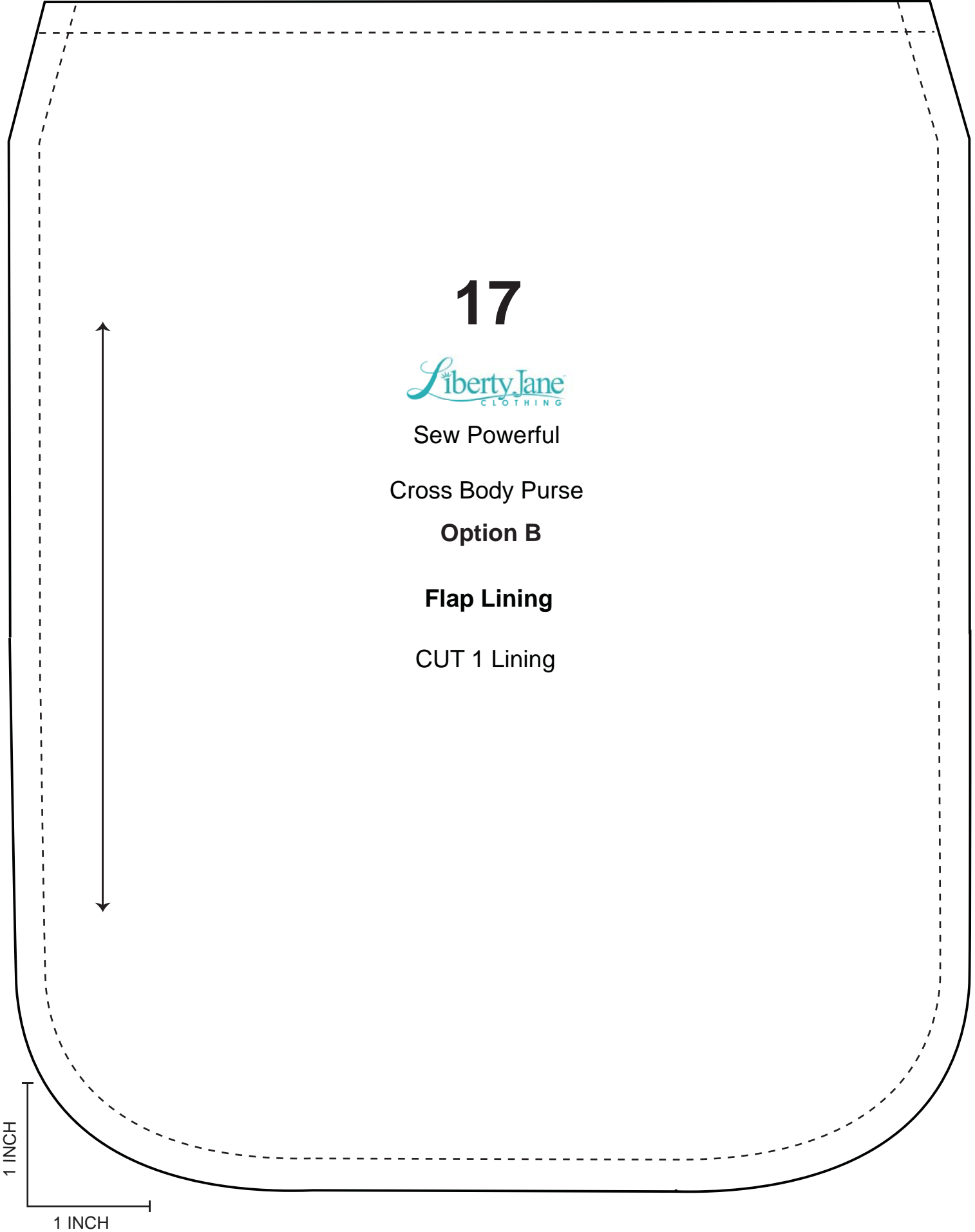



The Sew Powerful Purse Project

Project Overview:

Join us in our goal of collecting 1,000 purses for girls in need by October 1st.

Simply use the Liberty Jane Clothing Cross-Body Purse pattern and make as many (high quality) purses as you can. Our priority shipping deadline for the fall is October 1st, but we are happy to receive them all year long.

To download the pattern for free and get regular updates visit:
www.sewpowerful.org

Send your completed purses to:
Sew Powerful C/O Cally Leighton
16640 SE Old Petrovitsky Rd.
Renton, WA 98058

Visit www.sewpowerful.org for more information

Kuroda

Local Contact Coordinator Information

DUPLICATE FOR GROUPS & ENCOURAGE PARTICIPANTS TO WRITE A NICE NOTE TO THE RECIPIENT OF THEIR PURSE - THEN INCLUDE THE NOTE IN THE COMPLETED PURSE



sew powerful



sew powerful



A note about file sharing: You have received a copy of this digital product from Liberty Jane for your personal use and for the use of the Sew Powerful Purse project. We encourage you to share this with your friends and make lots of purses!

You do not have permission resell its contents, in any form - to anyone else. To do so would be a violation of the designer's copyright.

Copyright © 2015 Liberty Jane Clothing - All Rights Reserved

Share Your Projects With Us and Stay Connected!



LibertyJaneClothing.com



[Instagram.com/libertyjaneclothing](https://www.instagram.com/libertyjaneclothing)



[Facebook.com/LibertyJaneClothing](https://www.facebook.com/LibertyJaneClothing)



[Facebook.com/Sewpowerful](https://www.facebook.com/Sewpowerful)



[Pinterest.com/CinnamonMiles](https://www.pinterest.com/CinnamonMiles)



Jason@sewpowerful.org

Use **#sewpowerfulpurse** or **#libertyjane** when posting online.

Printing Info: A PDF reader is required to view and print the files (example: Adobe Reader or Preview for MAC). The pattern pieces are designed to fit on a standard 8.5 by 11 inch piece of paper. There is no resizing necessary. Be sure to print the file at 100%, Scale NONE, or Actual Size. The option may be worded differently depending on your print dialog box.